

**Note:**

- Dimensions in inches into brackets
- For missing dimensions see 3D file
- WHITE surfaces: mirror polished
- GREY surfaces: embossed 25/27 VDI
- RED surface: gate area. Sink mark injection will be present
- Ⓢ = Quality Control Dimensions (QCD)
- Planarity tolerance +/- 0.80 mm

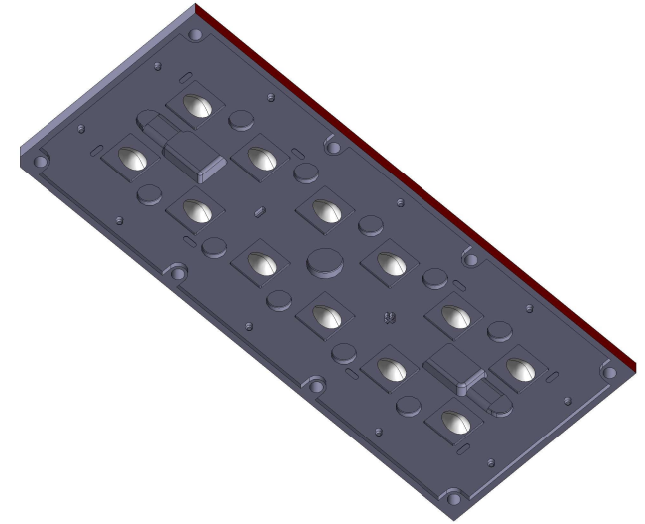
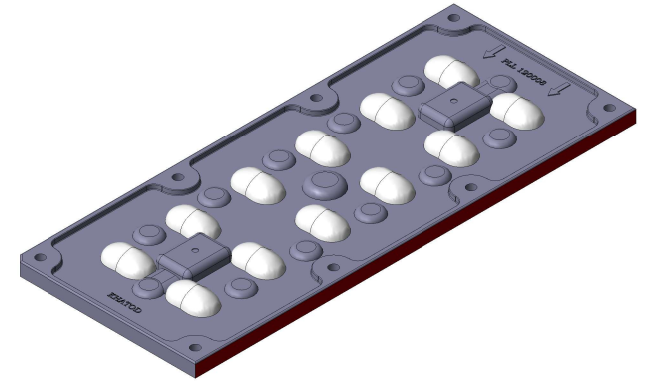
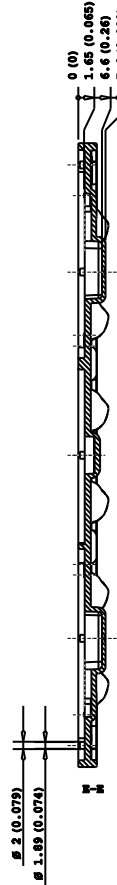
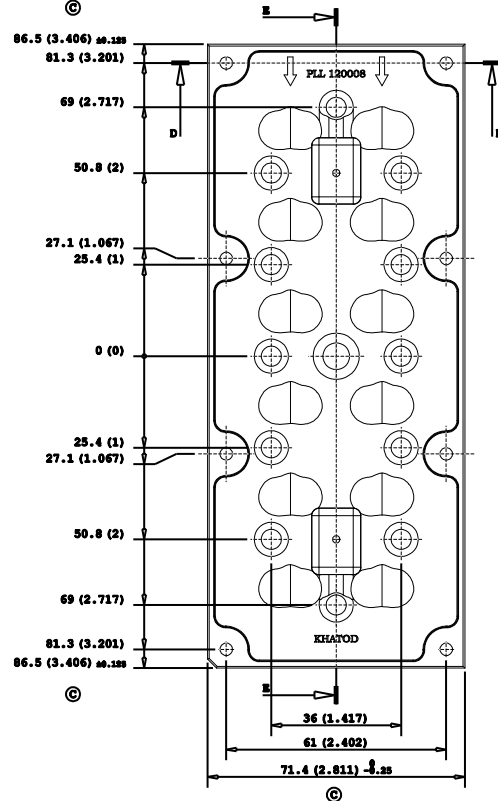
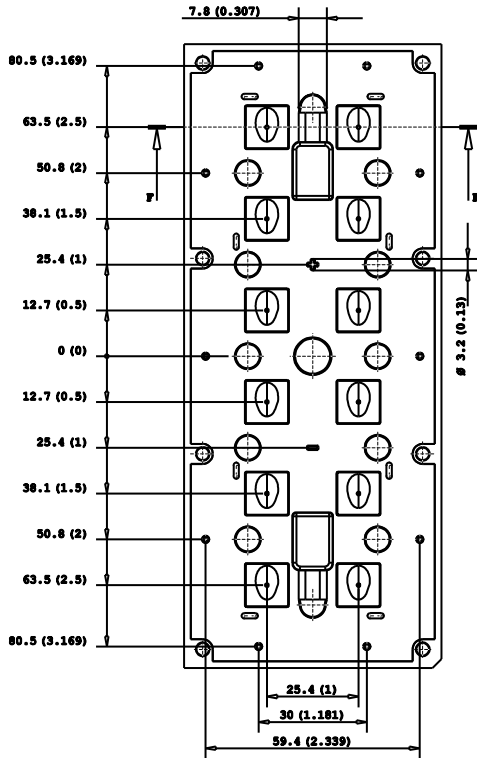
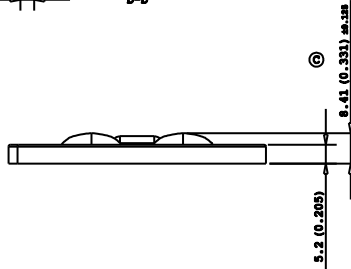
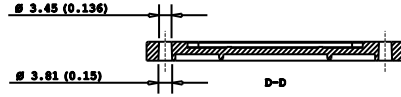

'' Project and design owned by Khatod OPTOELECTRONIC s. r. l.''  
The technical solutions adopted in this design are Khatod intellectual property, they cannot be reproduced and transmitted to third parties without our prior written permission.  
Unauthorized disclosure of confidential proprietary information will be prosecuted by law.

|   |   |                     |                        |
|---|---|---------------------|------------------------|
| DESCRIPTION : 12 Array lens   |   | DESIGNER : DP/KR/LM | PROJECTS : VI_II       |
| CODE : PLL 120008   | CHECKED :   | CONTROLLED: DP/LM   | DATA : 04/04/2017      |
| <b>KHATOD</b><br>Via Alessandrina,25<br>Cusano Milanino<br>MILANO<br>ITALIA<br>WWW.KHATOD.COM | All Dimensions in mm<br>General Tolerances +/-0.25 mm |                     | HEAT TREATMENT: No One |
|   |   |                     | MATERIAL: Pyrex 8N     |
| SCALE : 1 : 1   |   | SHEET : 1 of 1      |                        |