

Via Monfalcone 41  
20092 Cinisello Balsamo (Milano) – Italy  
Tel. +39 0266013695 – Fax +39 0266013500

**CODE NUMBER: 11000000074**

**SUBJECT: Secondary Optics for Power LEDs - PL117415  
Lens Coupling - Output Luminous Intensity Measurement**



- **Typ. Illuminance@1m ~ 2154 lux\***
- High lighting efficiency
- Excellent luminous flux
- No vibration problems
- NJC Technology
- Superior optical engineering for a perfect uniform light distribution
- Innovative design
- Easy fixing system to the PCB
- Complying with UL94 Specifications
- ☀️ UV Protected

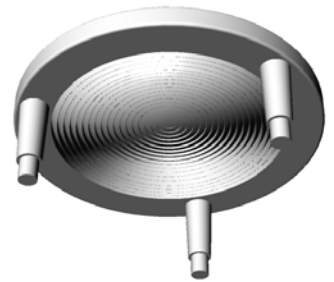

### **Typical Application are:**

- Wall Washing
- Architectural lighting
- Lamps
- Most applications where a compact light source is required
- Any application requiring placement of LEDs in narrow or recessed spaces, as well as in diverse LED configurations

Khatod Optics are a basic element to make your optical design real.

The right optical solution is fundamental for type and number of LEDs used in your design.

Advanced research, scientific rigour, great attention to the continuous evolution in LED Technology, have led Khatod to develop optical solutions performing an excellent, homogeneous luminous flux, and a high lighting efficiency.

The product we are proposing, is the result of Khatod's superior engineering. It helps in reducing the costs while meeting the most demanding lighting specifications and applications.

### **Contents:**

Technical Data	- Page 1
Polar Intensity Plot	- Page 2
Luminous Intensity Graphics	- Page 3
Technical Drawing	- Page 4
Photographic reproduction of the Spot	- Page 5
Luminous Distribution Intensity Data	- Annex A
General Lens Features	- Annex B
General Notes	- Annex B

### **Transmittance Curve vs Wavelength**

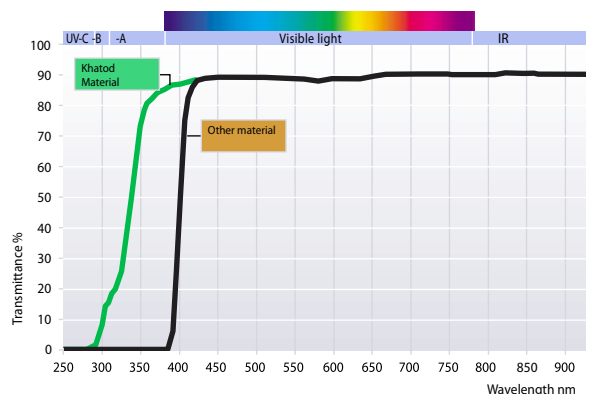

Via Monfalcone 41  
200092 Cinisello Balsamo (Milano) - Italy  
Tel. 0266013695 - Fax. +39 0266013500

**CODE NUMBER: 11000000074**

Goniophotometer Type	KLX12M	Operator	SIMONE BASSI
Power Supply Type	ISO TECH ISP3303	Date	15/02/2011
LED Driver Type	////		

Lamp Model	////	Nominal Flux (lm)	500	Angle FWHM C Plane	17
Lens Model	PL117415	Total Flux (lm)	500	Angle FWHM $\gamma$ Plane	16
LED Model	Generic Lambertian	Imax (cd)	1616		
N. LED	1	Max Ill. @ Meas. Dist. (lux)	65.6	Total Incl. Angle C Plane	30
Rated Voltage (V)	3.8	Measurement Distance (m)	5	Total Incl. Angle $\gamma$ Plane	28
LED Drive Current (mA)	1500	Room Temperature (°C)	25		

Notes:  
General Optical Measurement Tolerance: +/-10%

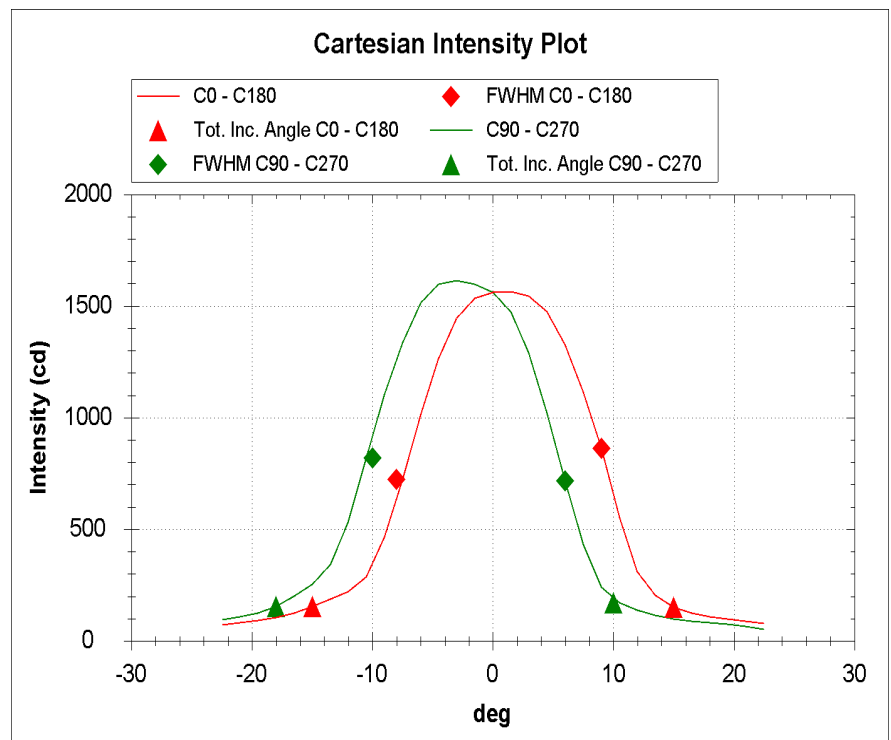
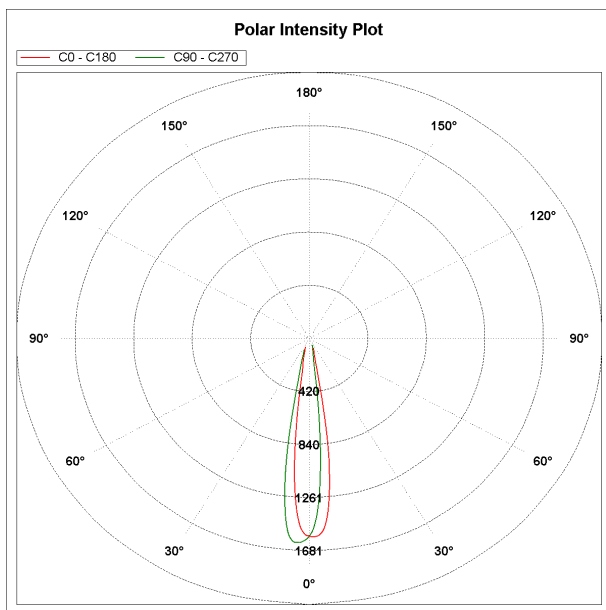

## Polar Intensity Plot

— C0 - C180    — C90 - C270

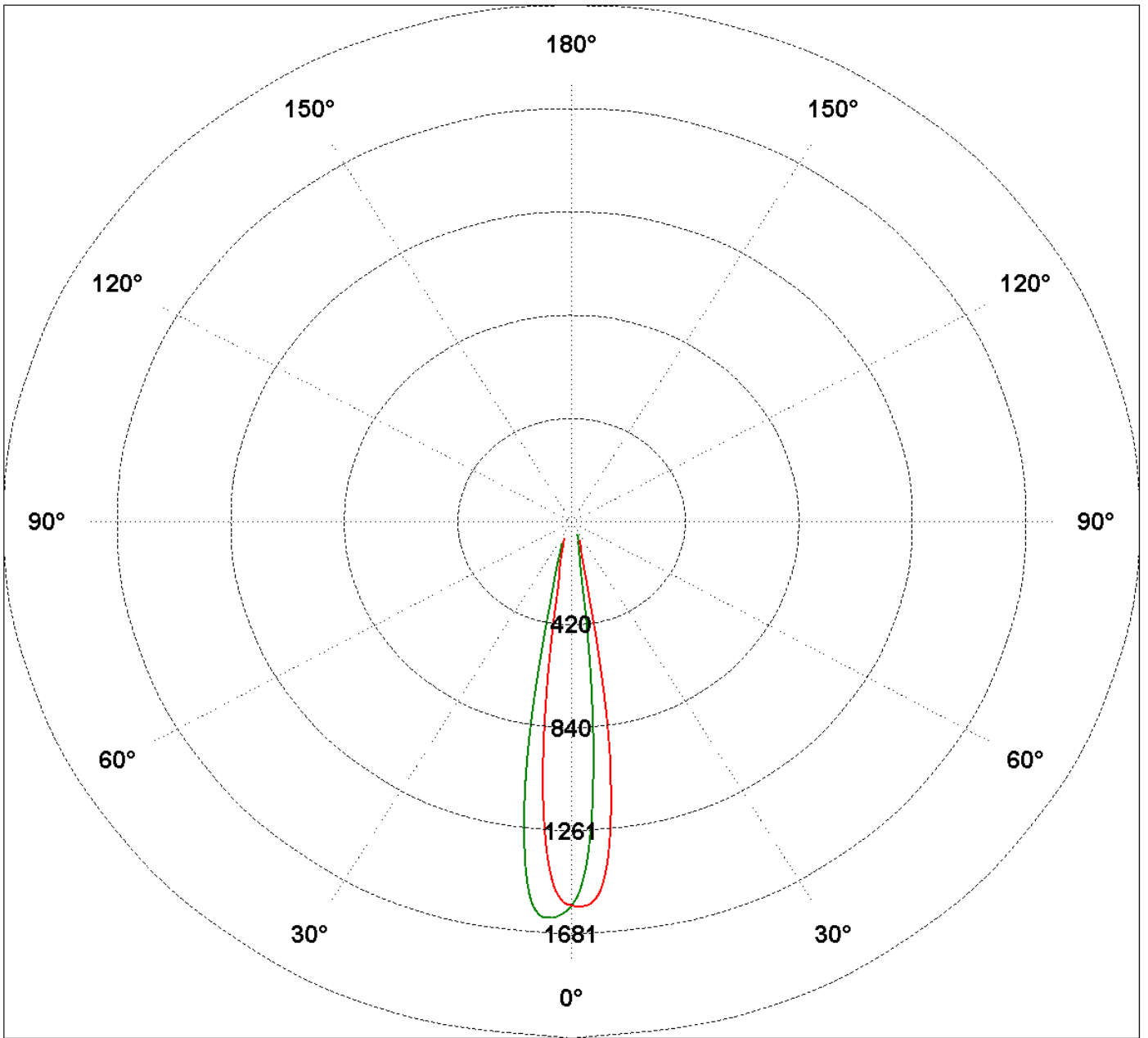

**CODE NUMBER: 11000000074**

Figure C0-C180

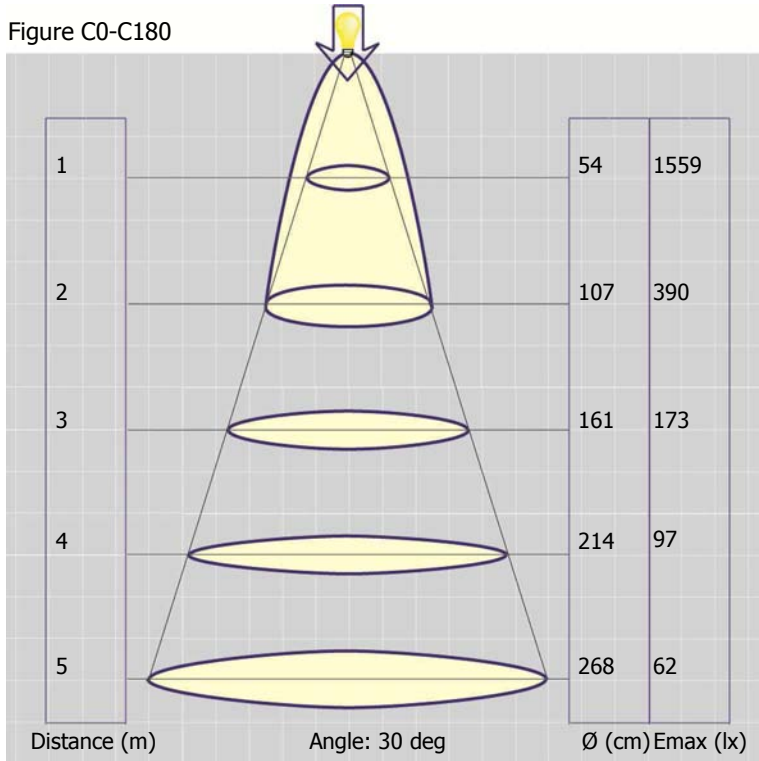
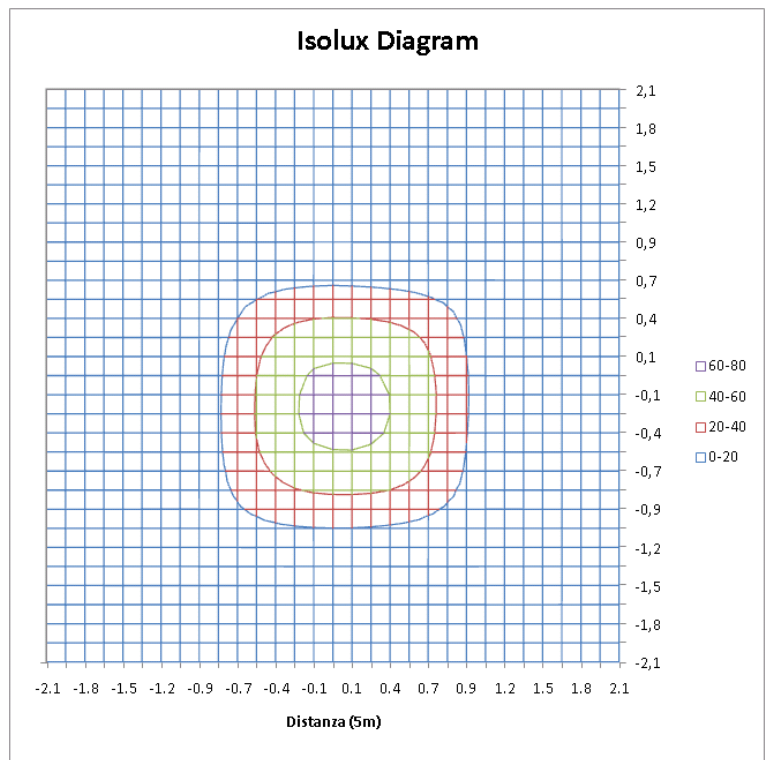
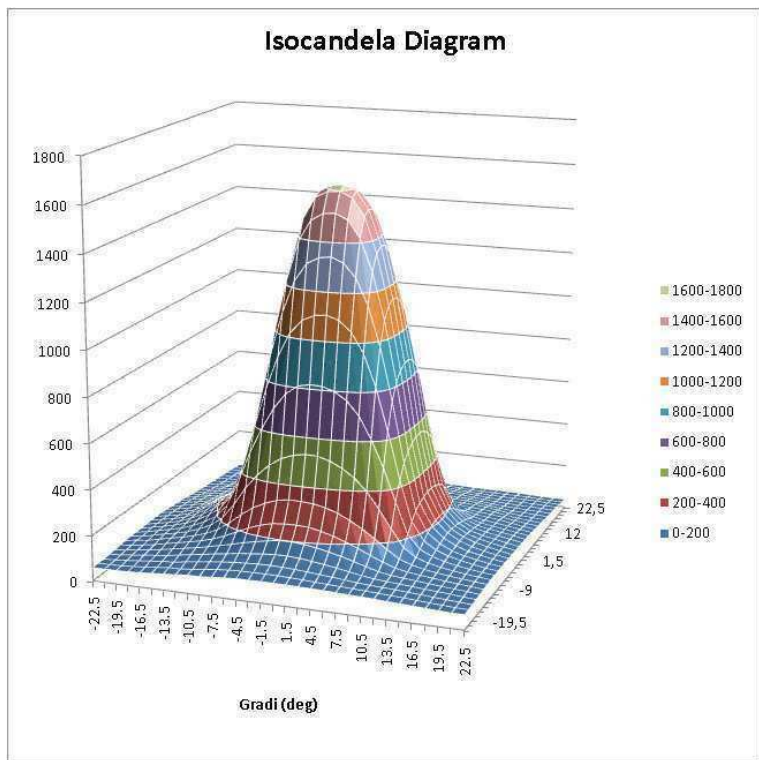
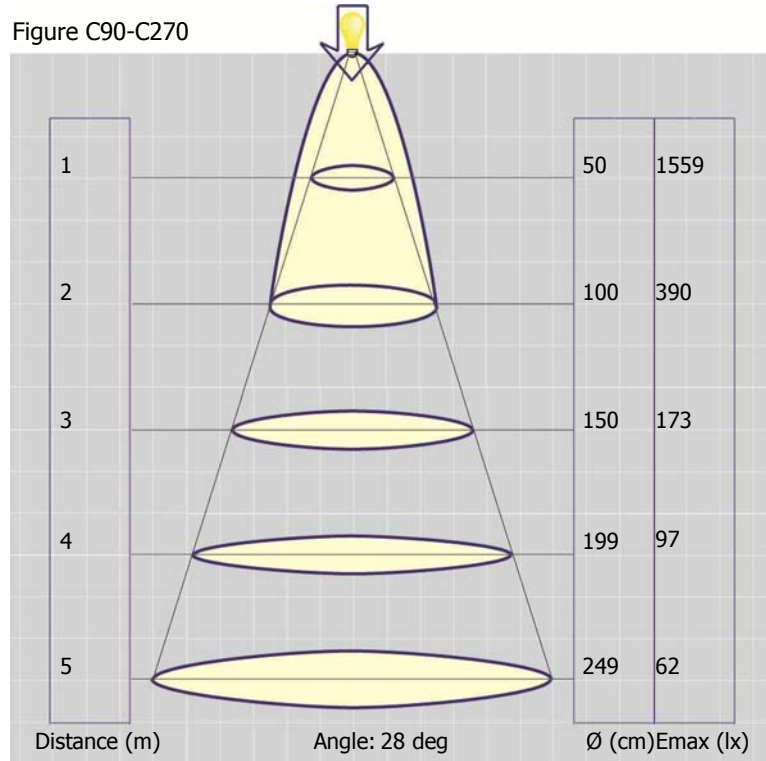
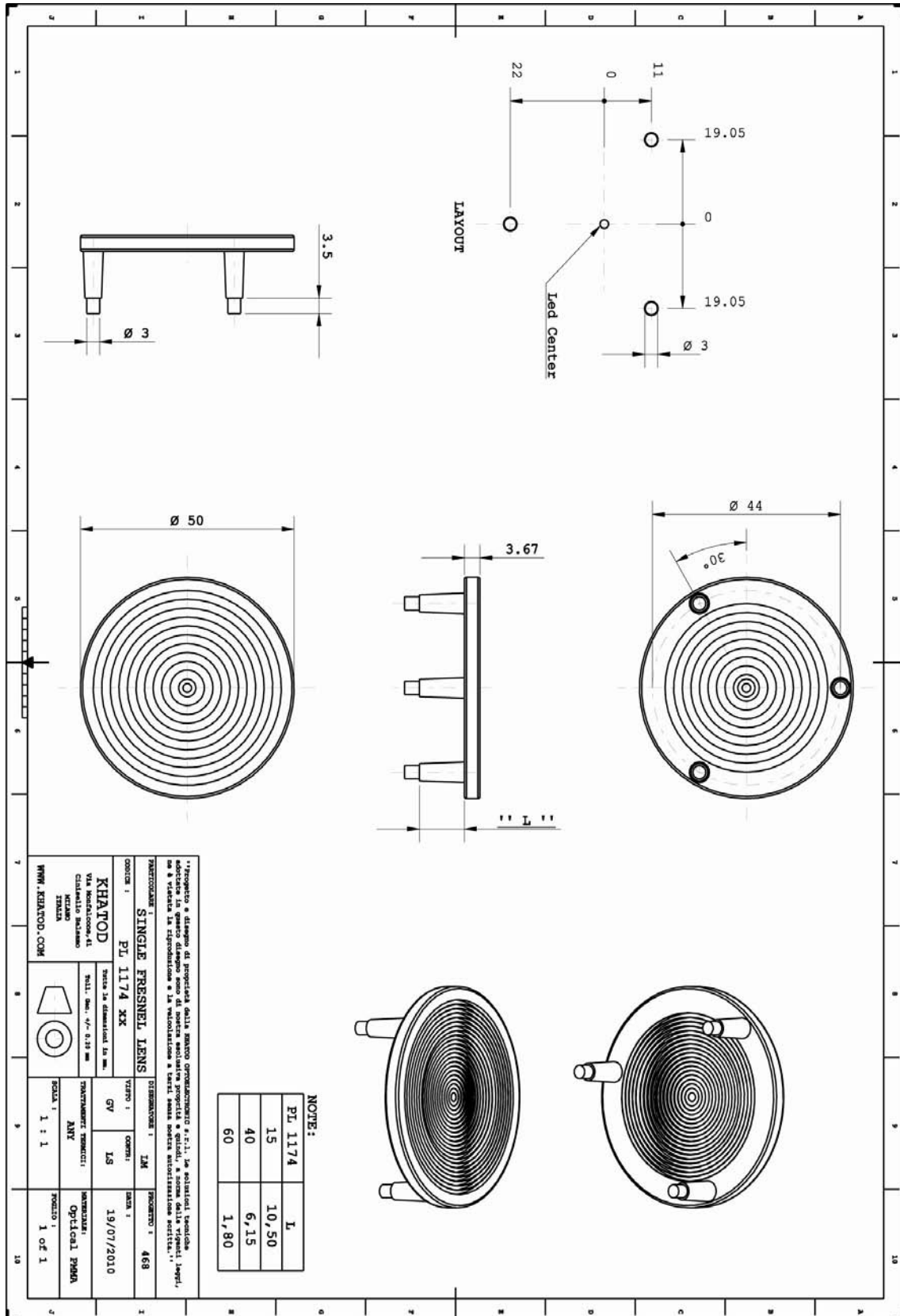
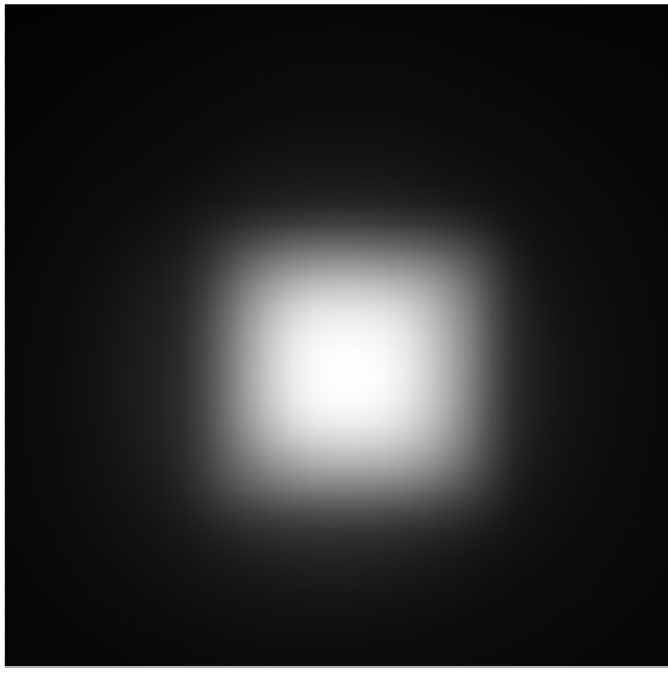

Figure C90-C270





Gray Scale Illuminance @ 5m Distance



False Colours Illuminance @ 5m Distance

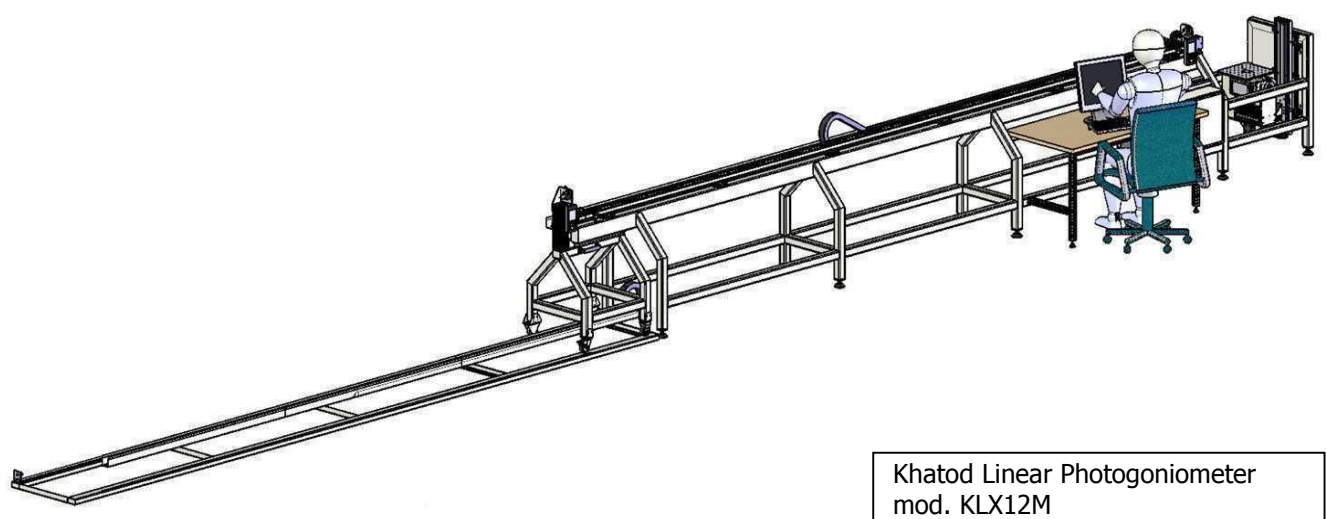
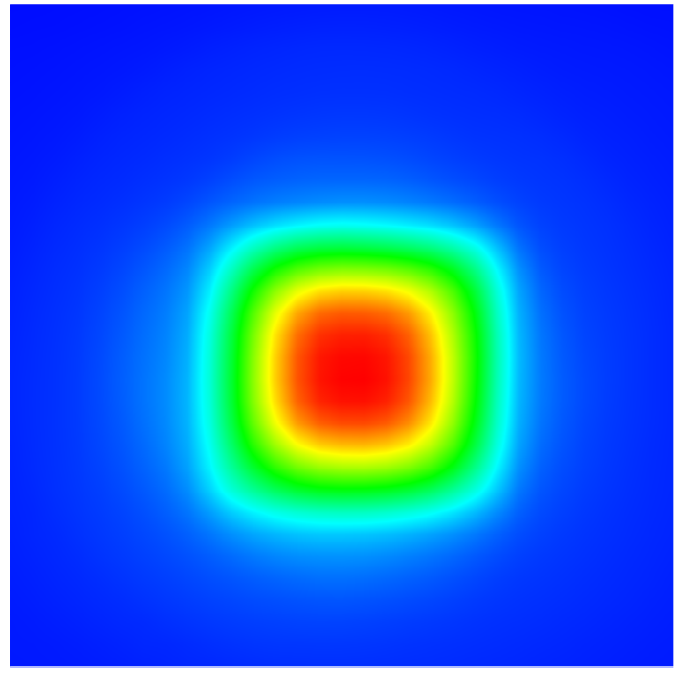

Khatod Linear Photogoniometer  
mod. KLX12M

## Luminous Distribution Intensity Data

CODE NUMBER: 110000000074

C (deg) γ (deg)	0°	10°	20°	30°	40°	50°	60°	70°	80°	90°	100°	110°	120°	130°	140°	150°	160°	170°	180°	190°
0°	1559	1559	1559	1559	1559	1559	1559	1559	1559	1559	1559	1559	1559	1559	1559	1559	1559	1559	1559	1559
5°	1424	1381	1341	1275	1200	1114	1038	974	932	920	926	955	994	1039	1080	1111	1138	1152	1180	1210
10°	654	649	653	603	481	339	253	212	199	194	196	205	238	290	344	353	344	340	345	374
15°	152	142	135	126	115	105	101	99.4	98.2	96.8	95.9	95.1	94.4	95.8	102	115	131	143	155	169
20°	94.3	90.7	88.2	84.8	79.8	74.4	72.1	72	72.7	72.1	71.3	69.2	67.9	67.6	69.5	73.1	79	83.7	87.9	92.2
25°	0	0	0	59.4	56.5	51.5	45.8	0	0	0	0	0	40.1	43.1	44.7	47.4	0	0	0	0
30°	0	0	0	0	0	0	0	0	0	0	0	0	0	0	0	0	0	0	0	0
35°	0	0	0	0	0	0	0	0	0	0	0	0	0	0	0	0	0	0	0	0
40°	0	0	0	0	0	0	0	0	0	0	0	0	0	0	0	0	0	0	0	0
45°	0	0	0	0	0	0	0	0	0	0	0	0	0	0	0	0	0	0	0	0
50°	0	0	0	0	0	0	0	0	0	0	0	0	0	0	0	0	0	0	0	0
55°	0	0	0	0	0	0	0	0	0	0	0	0	0	0	0	0	0	0	0	0
60°	0	0	0	0	0	0	0	0	0	0	0	0	0	0	0	0	0	0	0	0
65°	0	0	0	0	0	0	0	0	0	0	0	0	0	0	0	0	0	0	0	0
70°	0	0	0	0	0	0	0	0	0	0	0	0	0	0	0	0	0	0	0	0
75°	0	0	0	0	0	0	0	0	0	0	0	0	0	0	0	0	0	0	0	0
80°	0	0	0	0	0	0	0	0	0	0	0	0	0	0	0	0	0	0	0	0
85°	0	0	0	0	0	0	0	0	0	0	0	0	0	0	0	0	0	0	0	0
90°	0	0	0	0	0	0	0	0	0	0	0	0	0	0	0	0	0	0	0	0





Lens characteristics

Parameter	Symbol	Rating	Unit
Lens Material	PC Optics	--	--
Holder Material	--	--	--
Operating Temperature	Topr	-40 to +120	°C
Storage Temperature	Tstg	-40 to +120	°C

Notes:

Please note that flow lines and weld lines on the external surfaces of the lenses are acceptable if the optical performance of the lens is within the specification described in the section "OPTICAL CHARACTERISTICS"

- Should you require further information, please contact Khatod for advice.
- All lens testing must be subject to identical conditions as Khatod test condition.
- Published by Khatod optoelectronic srl - All the data contained in this document are the property of Khatod optoelectronic srl and may change without notice.

**KHATOD LENS Use And Maintenance**

- DO NOT HANDLE OR INSTALL LENSES WITHOUT WEARING GLOVES, SKIN OILS MAY DAMAGE LENS OR LIGHT TRANSMISSION
- CLEAN LENSES WITH MILD SOAP AND WATER AND A SOFT CLOTH
- DO NOT USE ANY COMMERCIAL CLEANING SOLVENTS ON LENSES

Khatod SRL, Milan, Italy, manufactures lenses for LEDs. Any other use of the lens shall void our liability and warranty. The lenses are an inert component to be used in the manufacture of various products. Our warranty and liability are limited only to the manufacture of the lens. You may not modify, copy, distribute reproduce, license or alter the lens and related materials of Khatod SRL. Khatod SRL does not warrant against damages or defects arising out of the use or misuse of the products; against defects or damage arising from improper installation, or against defects in the product or in its components. No warranty of any kind, expressed or implied, is made regarding the safety of the products. The entire risk as to the quality or performance of the product is with the buyer. In no event shall Khatod SRL be liable for any direct, indirect, punitive, incidental, special, consequential damages, or any damages whatsoever arising out of or connected with the use or misuse of the product. Khatod SRL shall not have any obligation with respect to the product or any part thereof, whether based on contract, tort, strict liability or otherwise. Buyer assumes all risks and liability from use of the product. The laws of Milan, Italy govern this product warranty and liability and you hereby consent to the exclusive jurisdiction and venue of courts in Milan, Italy in all disputes arising out of or relating to the use of this product.

